



The Technology Leader

Heller has been honored with many major industry awards including: 2018 Service Excellence Award, 2017-2018 Vision Award for Innovation, Market Share Leader, and 2018 Frost & Sullivan for Global Company of the year Award.



We welcome you to visit any of our three Centers for Excellence — USA, China and Korea. Operators and engineers can attend “Heller University” to learn about lead-free processing, troubleshooting and advanced applications solutions.

Localized engineering, service, spares, process support and training facilities separate Heller from the competition. This “Glo-Cal” business model (GLObal company with LoCAL strength) has earned Heller the Market Leader position and make us the obvious choice for reflow soldering solutions worldwide.

Benefits of Partnering with the World Leader

Working with the industry leader carries many other important benefits:

- Partnership:**
 We provide the V.I.P. service and support that has come to symbolize Heller Industries.
- Corporate Strength and Longevity:**
 Over 55 years in the electronics industry gives us a solid corporate and management base that ensures stability and continued support.
- Direct Access to Upper Management:**
 Our upper management staff is continually traveling to meet our customers to gain their feedback and input.
- Distributed “Lean” Manufacturing:**
 With factories in China and Korea, we provide “local” sourcing and utilize a “copy exactly” paradigm that ensures Six Sigma performance oven-to-oven and factory-to-factory.

Heller China



Heller Korea



Heller USA

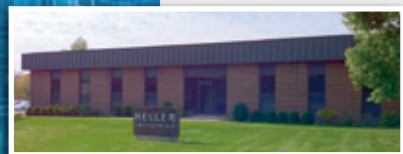

- Heller Factories
- Heller Sales/Service Offices
- Heller Industry Representatives



Heller Industries, Inc.
 4 Vreeland Road
 Florham Park, New Jersey 07932 USA
 Tel: 973.377.6800 | Fax: 973.377.3862
 E-mail: info@HellerIndustries.com
 Web Site: www.HellerIndustries.com

Heller Industries, Inc. Shanghai
 Building 10-11 No. 318, Yuan Shan Road
 Min Hang District, Shanghai 201108, P.R. China
Heller Industries Inc. Korea
 125-5, Saneop-ro 156 Beon-gil,
 Gwonseon-gu Suwon-si, Gyeonggi-do, Korea

Eastern US Office
 973.377.6800
 Info@hellerindustries.com

Western US Office
 512.454.4057
 Info@hellerindustries.com

Europe Office
 +441.16.223.8107
 Info@hellerindustries.com

Korea Office
 +82.31.740.9210
 Info@hellerindustries.co.kr

China Office
 +86.21.6442.6180
 Info@hellerindustries.com.cn

Japan
 +81.3.6717.4001
 Info@hellerindustries.com

The MARK 5

1505

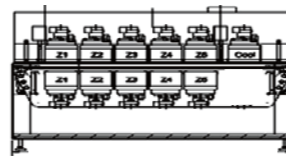

Model	Overall Length	# of Heat Zones	# of Cool Zones	Max PCB Width
1505	79" (2m)	5	1 Top (std.) External Cool optional	22"

1707

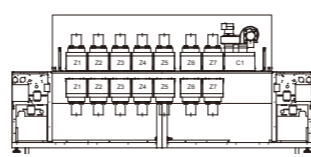

1707	142" (3.6m)	7	1 Top (std.) Bottom Cool/ External Cool optional	22"
------	-------------	---	--	-----

1826/1809

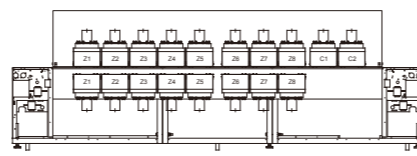

1826	183" (4.65m)	8	2 Top (std.) Bottom Cool/ External Cool optional	22"
1809	183" (4.65m)	9		22"

1936/1913

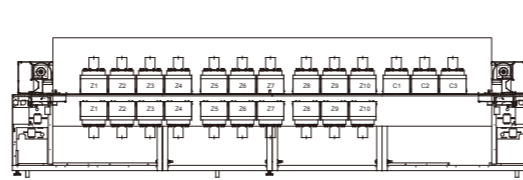

1936	232" (5.89m)	10	3 Top (std.) Bottom Cool/ External Cool optional	22"
1913	232" (5.89m)	13	3 (Air)/4 (N2) Top (std.) Bottom Cool/ External Cool optional	22"

2039

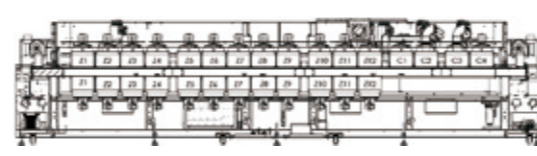

2039	267" (6.78m)	12	4 Top (std.) Bottom Cool/ External Cool optional	22"
------	--------------	----	--	-----

2043

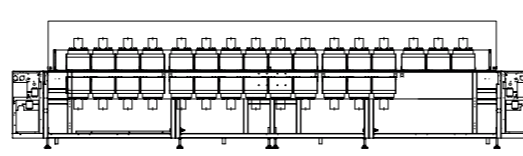

2043	267" (6.78m)	13	3 Top (std.) Bottom Cool/ External Cool optional	22"
------	--------------	----	--	-----

2049



2049	301" (7.65m)	15	4 Top (std.) Bottom Cool/ External Cool optional	22"
------	--------------	----	--	-----

2156

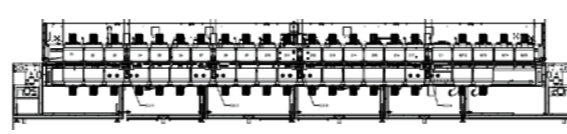

2156	342" (8.69m)	17	5 Top (std.) Bottom Cool / External Cool Optional	22"
------	--------------	----	--	-----

NOTE: 1826+1936+2039+2049+2156 models utilize a 30" wide by 12" long heater module to allow drop-in profile compatibility with other vendors' ovens. 1505+1707+1809+1913 models utilize a 30" wide by 10" long heater module to provide improved profile "sculpting" and reduced liquid times. Module sizes up to 36" wide are available upon request for large boards up to 28" wide and increased dual rail width.

HELLER INDUSTRIES
 THE TECHNOLOGY LEADER

HELLER INDUSTRIES
 THE TECHNOLOGY LEADER

ADVANCED TECHNOLOGY
 FOR DEMANDING PROCESSES



IN TECHNOLOGY
 INNOVATIONS

THE WORLD'S BEST Convection Reflow Oven



TECHNOLOGY
for the ENVIRONMENT

Heller Industries has been able to provide its customers with ways to optimize their operations and increase their productivity — all while minimizing its environmental footprint, utilizing fewer resources and enhancing sustainability.

INDUSTRY 4.0
Compatibility



Internet of Manufacturing (IoM) — Smart factories, intelligent machines and networked processes through the use of cyber-physical systems.

Heller offers Host Computer/IoM Interfacing.
This integration provides:

- Central control
- Production reporting — # of boards processed, up time, down time
- MTBF / MTTA / MTTR
- Energy management and control
- Traceability of product

Heller offers compatible interfacing for:

- CFX (AMQP MQTT)
- Hermes
- PanaCIM & iLNB
- Fuji Smart Factory
- ITAC
- Custom interfaces available upon request

INNOVATIONS



2019 Service Excellence Award



2020 Winner - Global Company of the Year Award



Recognized Leadership

Our focus on technology-driven solutions in partnership with our customers has been consistently recognized throughout the years by several industry agencies. This recognition validates our market leadership and confirms that Heller is at the forefront of the technology curve — constantly bringing new innovations to market faster and with greater impact than our competitors.

NEW!

Process Monitoring and Traceability — Built-in!

This revolutionary feature automatically logs actual zone temperatures, belt speed and O2 PPM for each PCB. The Heller 365 Level 1 software algorithm compares actual data to set points and verifies that the process is in spec. The system provides full management reporting and trend data so managers can take proactive steps for P.M. or servicing and avoid downtime before it happens!

Traceability feature allows barcode or date stamp search of past production runs to research field failures and QA returns. Great for automotive and high-spec processing operations!

Heller 365 level 2 & 3 system allow for simulated profile graphs to be generated for EACH PCB as it runs through the oven, software compares simulated and baseline profile to ensure repeatability on ALL PCB's.

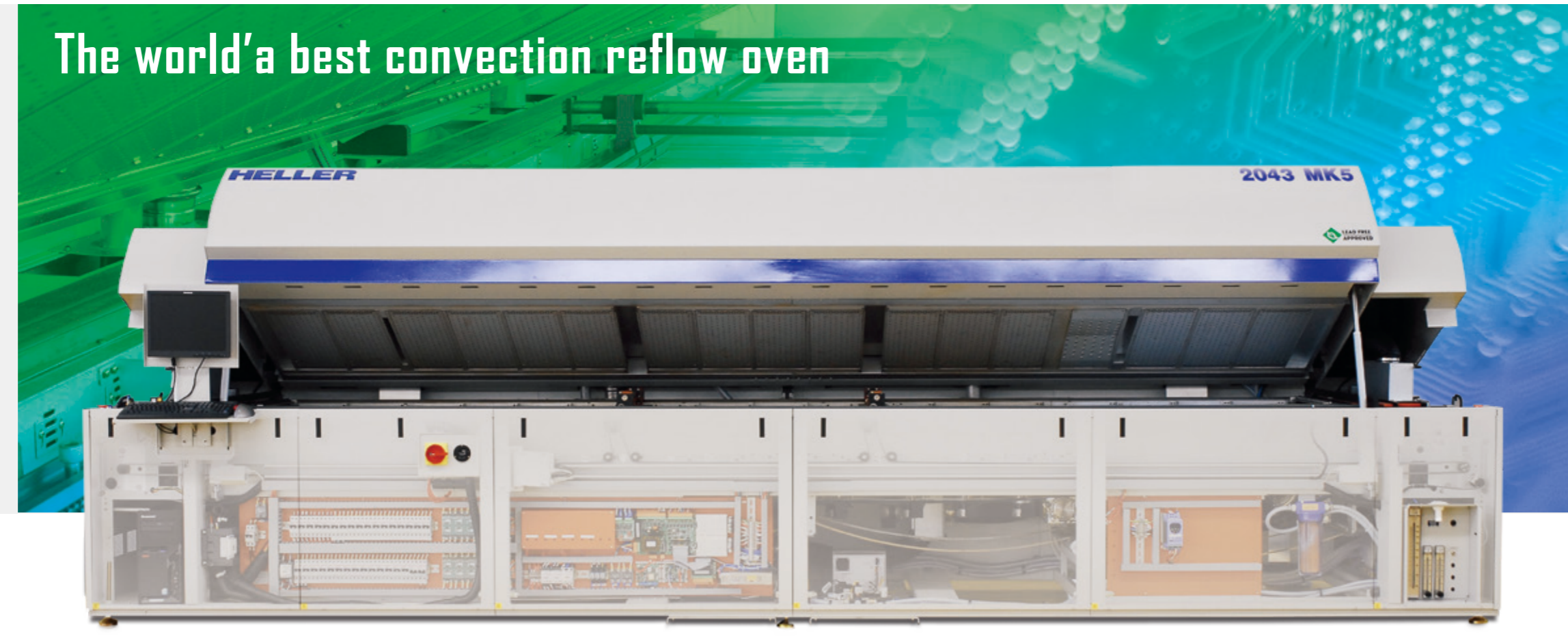

The world's best convection reflow oven

The latest breakthroughs associated with the Mark5 (MK5) reflow system makes it not only the premier reflow soldering system, but the best overall value in the industry!

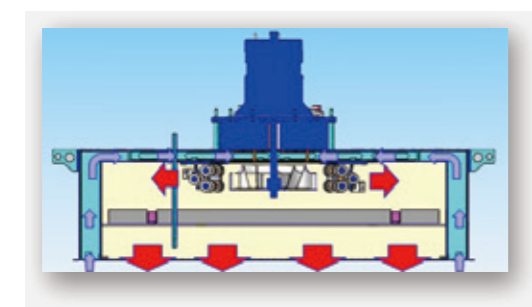

Semi-Circular Heater Modules

Semi-circular heater module with 40% larger impeller, blanket the PCB with heat for the lowest delta Ts on the toughest boards! Additionally, the Uniform Gas Management system eliminates net flow which results in nitrogen consumption reductions of up to 40%!

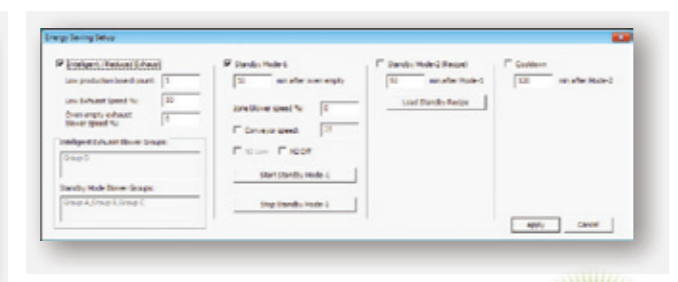

Energy Management Software — A Heller Exclusive!

Proprietary software allows you to program exhaust draw to optimize energy consumption during the various production times — heavy, light or idle.

One-Step Profiling

Developed in partnership with KIC, you can have instant profile settings by simply entering the length, width and weight of your PCB.



Water Cool Pipe Flux Collection System Eliminates Maintenance and Better Cooling Performance

Our Water Cool Pipe flux collection system traps the flux in collection jars that can be easily removed and replaced while the oven is running — saving time consuming P.M.

The active cooling capacity from both outer and inner pipes of the water jacket achieves a better cooling performance.

Additionally, our proprietary Flux-Free Grill system limits the flux residue on the cooling grills — the result is not only reduced maintenance time but recaptured production time — giving the Heller system the highest production yields of any oven!

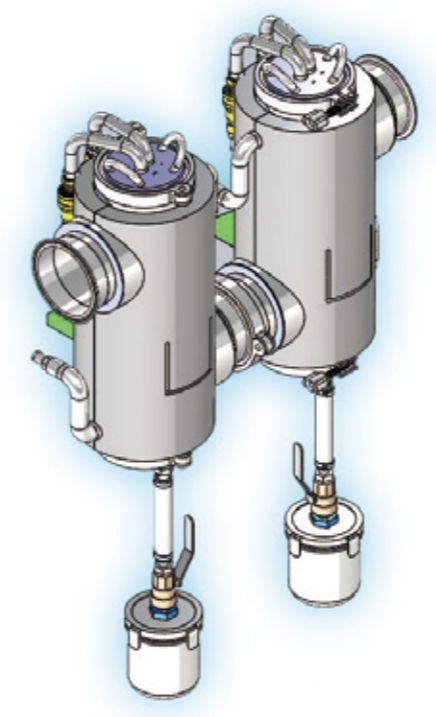

Fastest Cooling Rates

The new Blow-Thru Cooling module provides cool rates of >3° C/sec. — even on heavy mass boards! That rate meets the most demanding lead-free profile requirements!

